

# Pilz / Tillig-Antrieb (86112)

## Pilz / Tillig-Drive (86112)

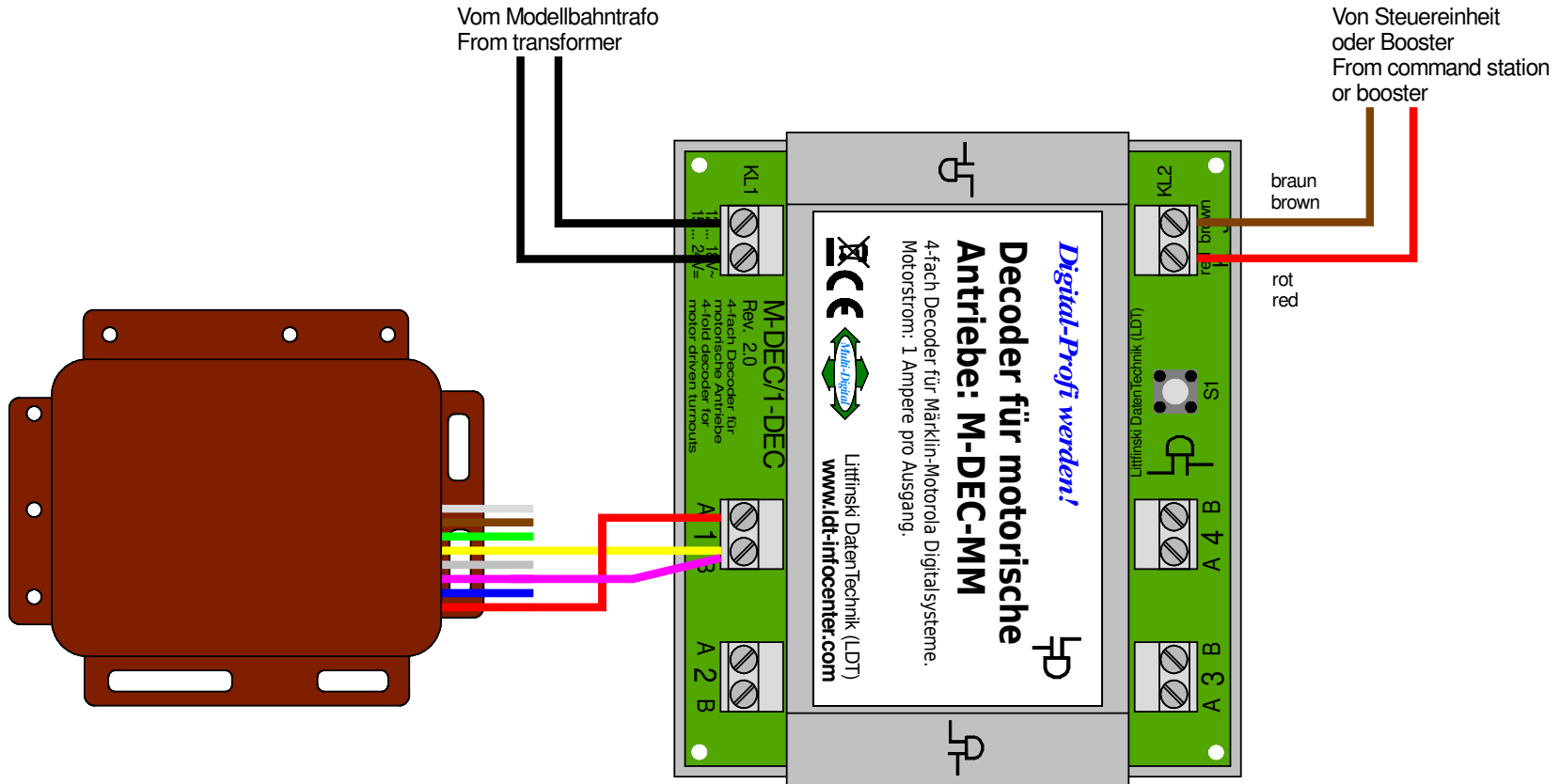

Technische Änderungen und Irrtum vorbehalten.  
Subject to technical changes and errors.

© 01/2020 by LDT

