

# Decoder extern versorgen (Gleichspannung)

## External supply to the Decoder (DC voltage supply)

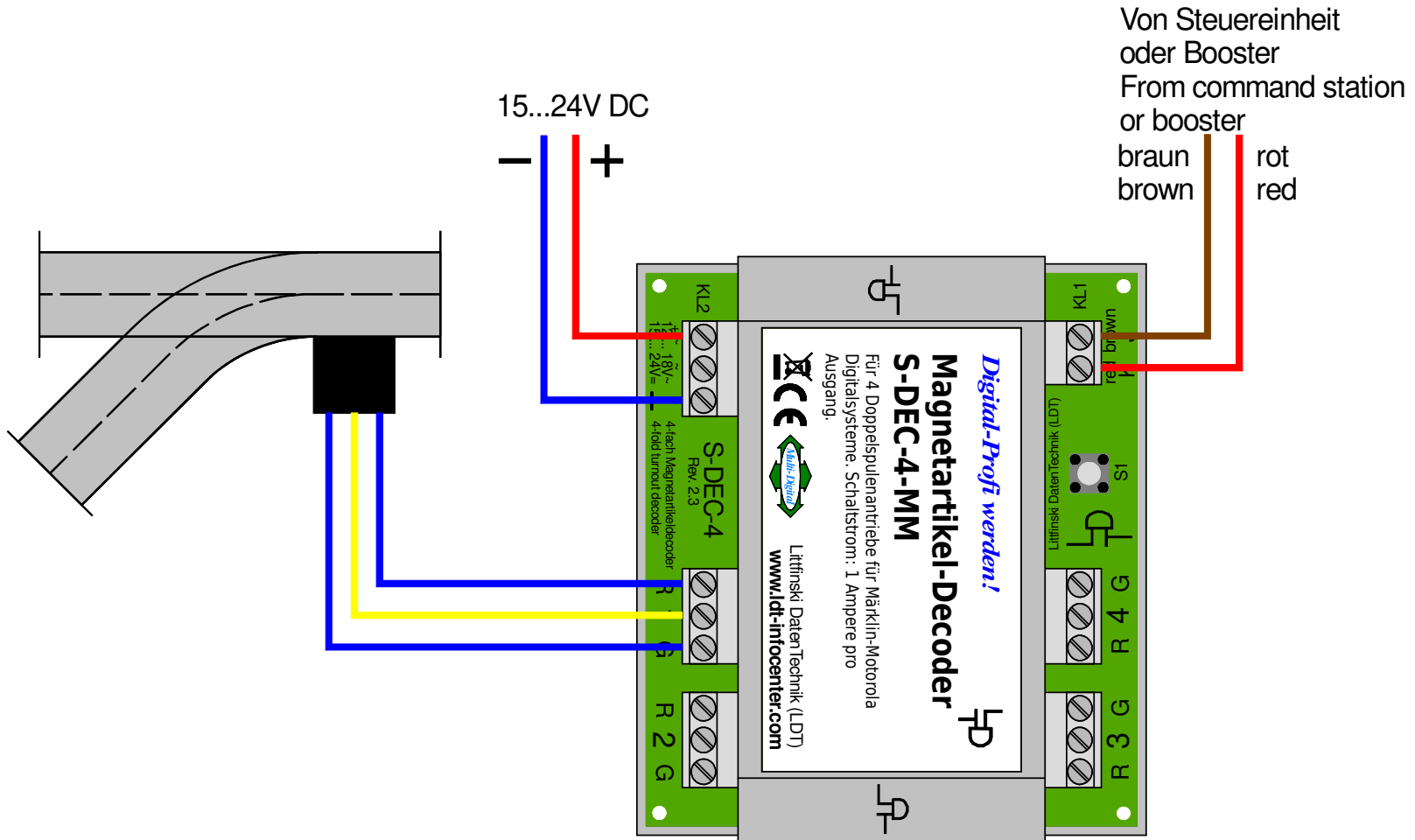

Technische Änderungen und Irrtum vorbehalten.  
Subject to technical changes and errors.

© 01/2020 by LDT