

Light-Power: Zwei Light-Power-Module am Light-Interface

Light-Power: Two Light-Power-Modules at the Light-Interface

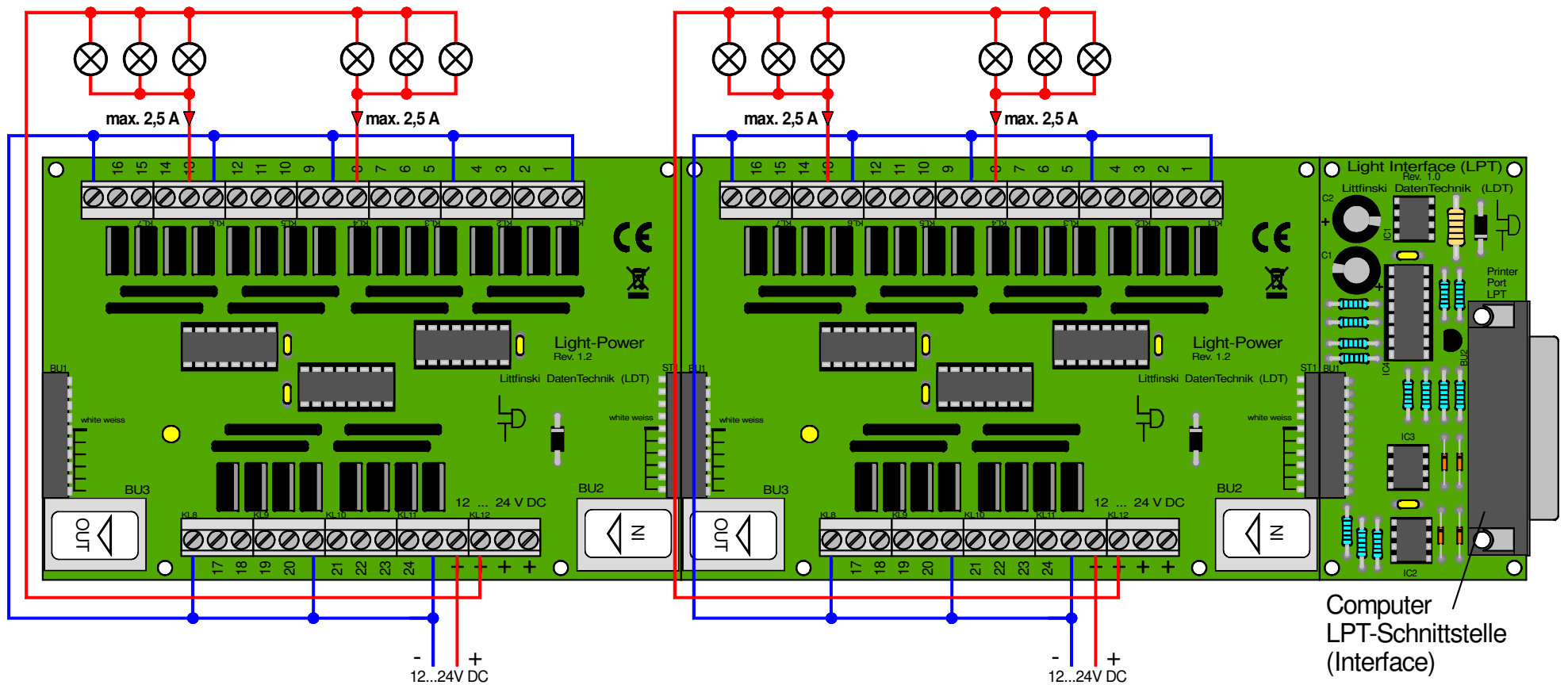

Technische Änderungen und Irrtum vorbehalten.
Subject to technical changes and errors.
© 09/2014 by LDT

