

Versorgung von überwachten Streckenabschnitten (Gleisbelegmeldung) (mit DB-4) / Patch-Kabel nach s88-N
Supply of monitored track sections (track occupancy feedback) (with DB-4) / patch-cable to s88-N

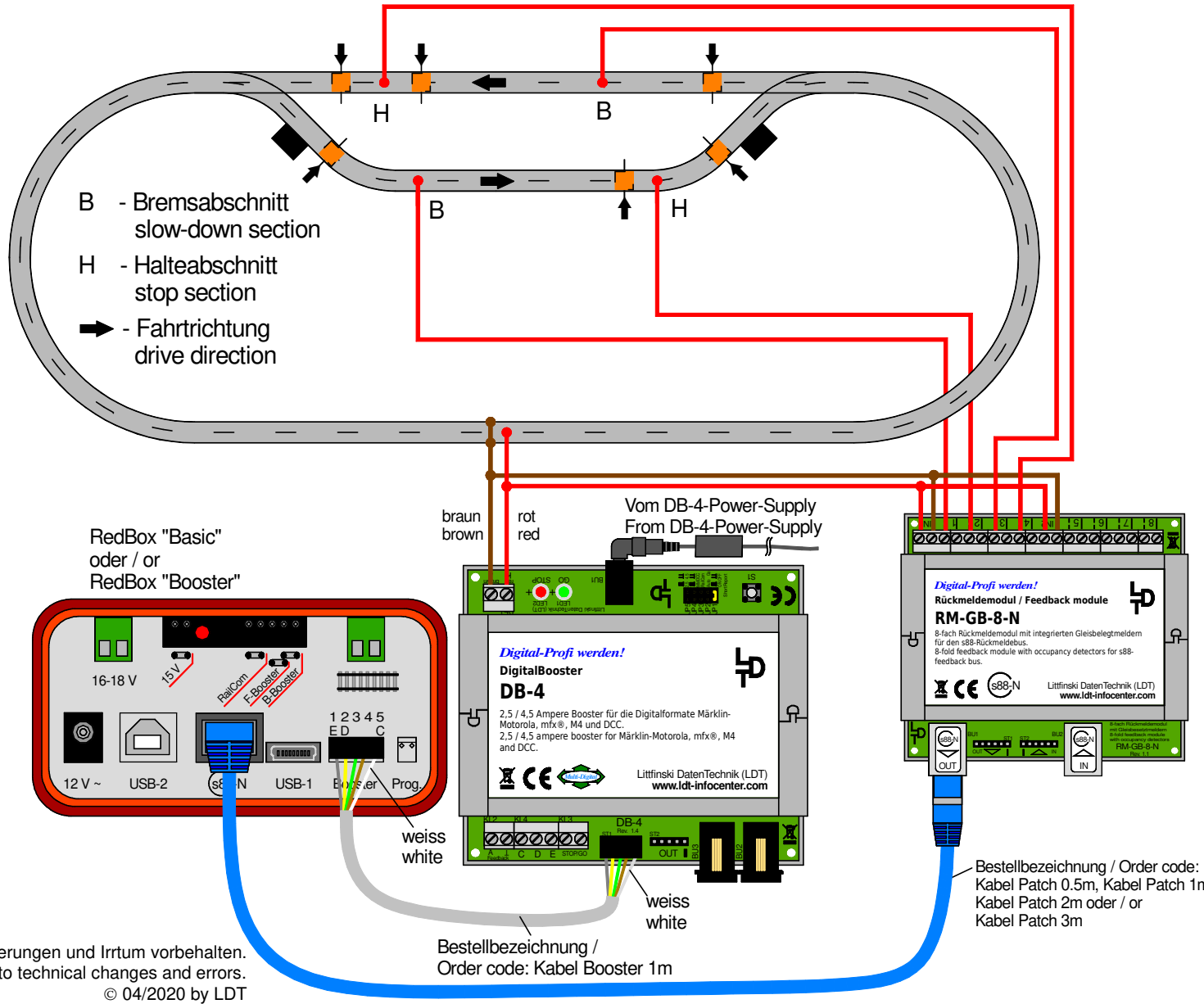

Technische Änderungen und Irrtum vorbehalten.
Subject to technical changes and errors.
© 04/2020 by LDT

