

Extra Digitalstromleitung für die Decoder

Separate digital-current conductor for the decoder

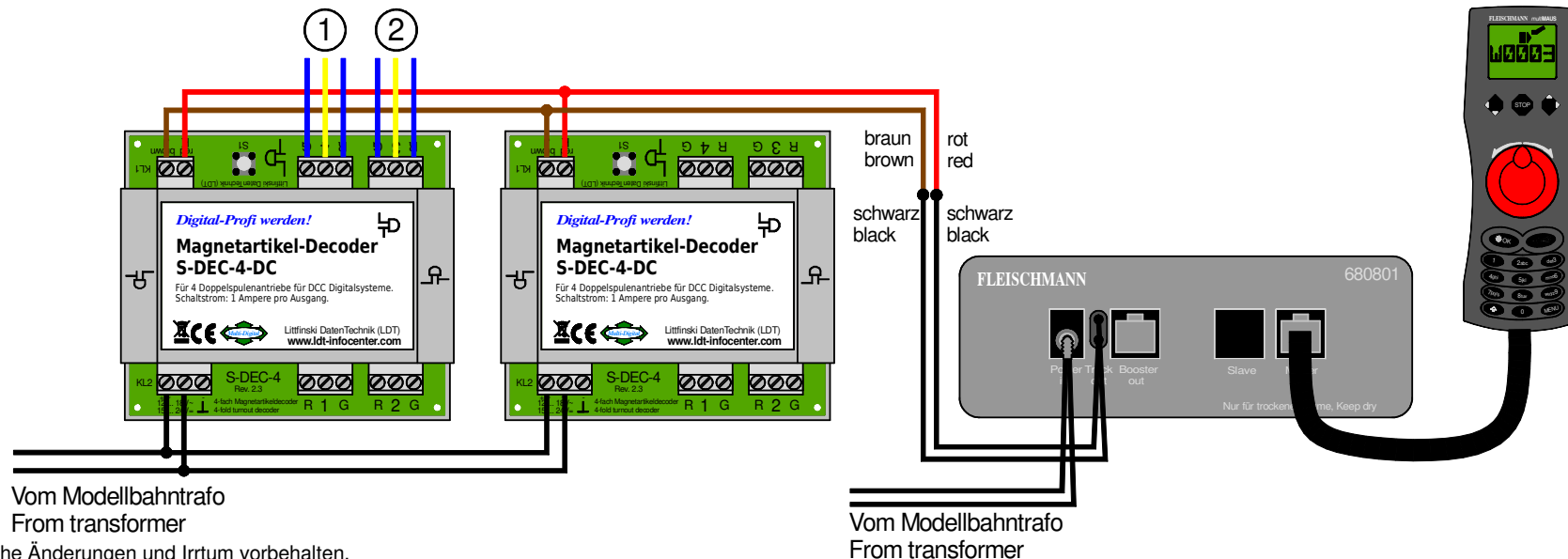
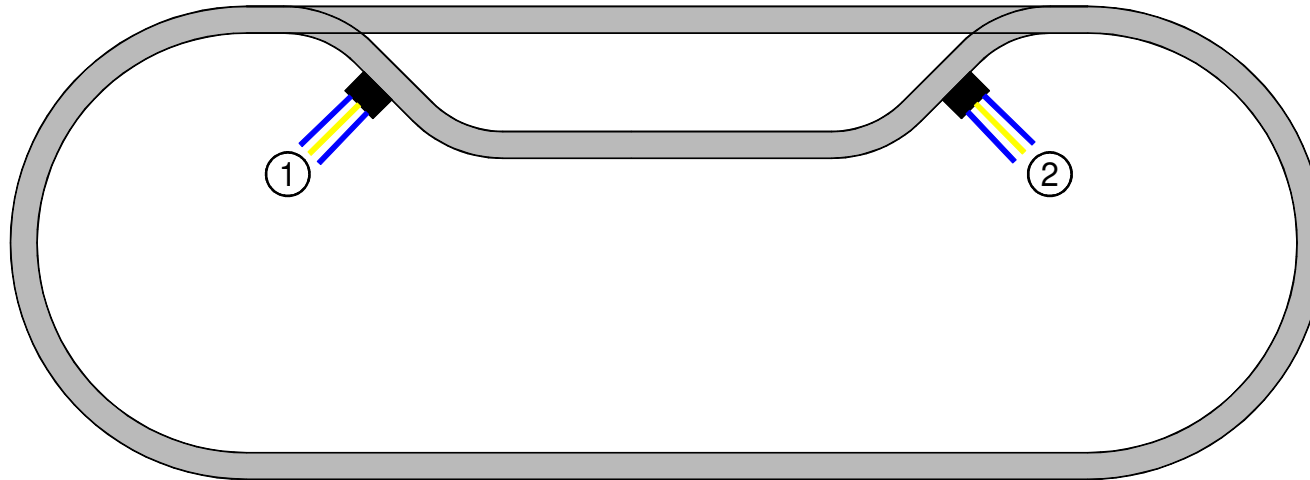

Technische Änderungen und Irrtum vorbehalten.
Subject to technical changes and errors.
© 09/2020 by LDT