

To be a Digital-Professional!

Digital driving and switching of dual-coil drives with Central Station 2 (60213/60214/60215) / Märklin-Motorola data format)

The main focus of this chapter shall cover the simple installation und use of the first Turnout Decoder “*S-DEC-4-MM*” for dual-coil drives and switching of turnouts or semaphore signals.

The first step by the construction of a digital controlled model railway layout is the installation of the digital driving. For the realization of the digital driving has the command station (Central Station 2) to be connected to a power supply and to the rails. The second step is the installation of the digital switching. The first decoder can now be connected to the supply voltage and to the digital output of the central unit.

Many of the described cable colors are typical for digital model railway layouts. Naturally is it within your option to use cable colors to your requirement. Nevertheless you should assure right at the beginning: remain to the selected cable color system and make a careful documentation for possible future fault diagnosis, for extending the system or for modification of the system.

■ General Note

CONNECTING THE CENTRAL STATION 2

The Märklin manual recommends the 60 VA transformer 60052 for the current supply of the Central Station 2.

According to the manual is it not permitted to supply other consumers with the Central Station 2 transformer as well.

All our decoder with external current supply possibility contain a galvanic separation between the digital circuit and supply circuit. Therefore is the supply of the decoder from Central Station 2-transformer possible without any problems.

For the wires of the rail connections (**red / brown** =digital current) the following wire sizes are recommended:

length of the cable	recommended cross section
up to 3 meter	0.75 mm ²
up to 6 meter	1.5 mm ²
up to 10 meter	2.5 mm ²
more as 10 meter	4.0 mm ²

For preventing power losses at the wires is it recommended to use a (first) mains ring conductor with connections to the rail system (**red / brown**) at distances of 1.5 to 2m. Each plugged rail connection will contain an electrical resistance.

This resistance will be enlarged by corroded contacts etc. The resulting voltage-drop at the rail connections reduces the digital voltage and it can be possible that “remote” track sections will eventually not get the full digital voltage – disturbances or inexplicable abnormal behavior can be expected. A sufficient diameter of the supply-wires will contain a considerable lower resistance and assures therefore the full supply of the voltage to the rails.

The below picture shows the general connection of a command station and the additional power supply connections at your model railway layout:

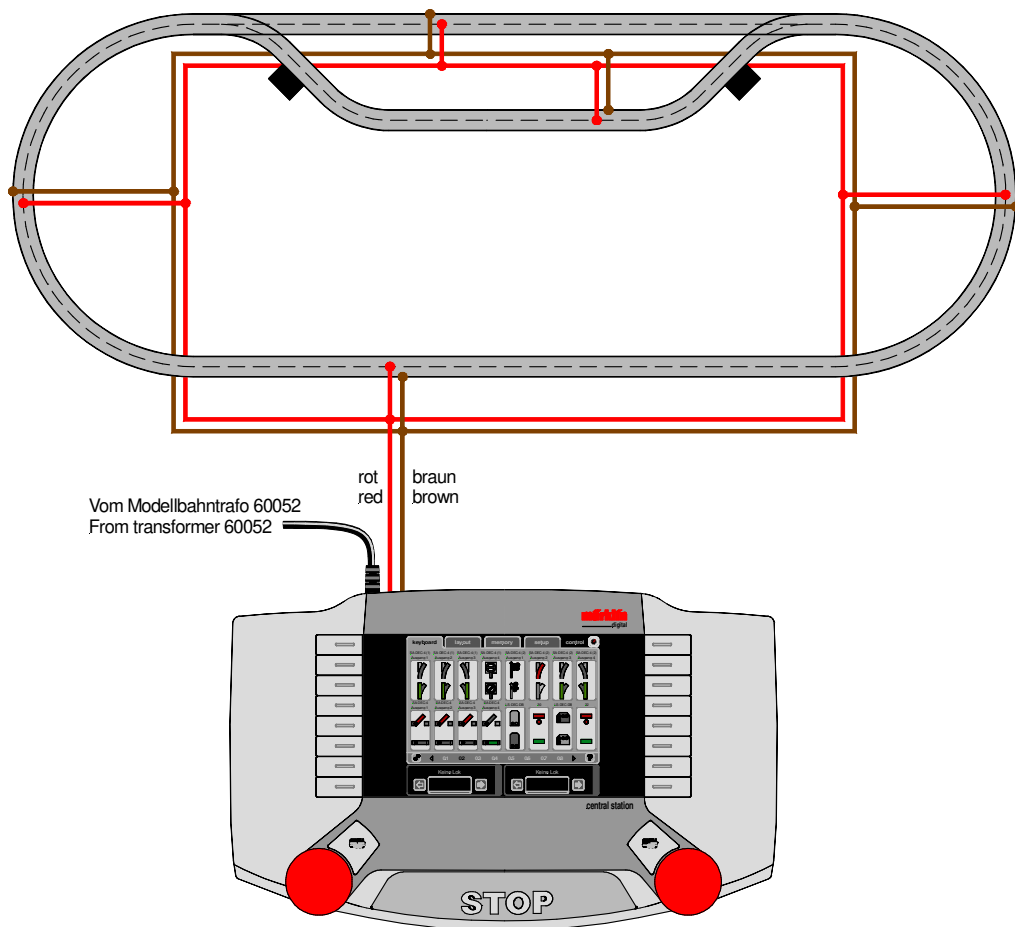

■ Connection of the Central Station 2 (page_548)

THE FIRST TURNOUT-DECODER (*S-DEC-4-MM*)

Now to the second step on the way of digital switching at your digital model railway layout.

The Märklin Central Station 2 uses the MOTOROLA-data format for transmittance to the driving of locomotives and for the switching. For this data format we offer our 4-fold Turnout Decoder “*S-DEC-4-MM*” within our program.

Also the Turnout-Decoder require a connection to the power supply (12 – 18 V ~) and to the digital voltage. All digital commands to the loc-decoder will be transmitted on this way.

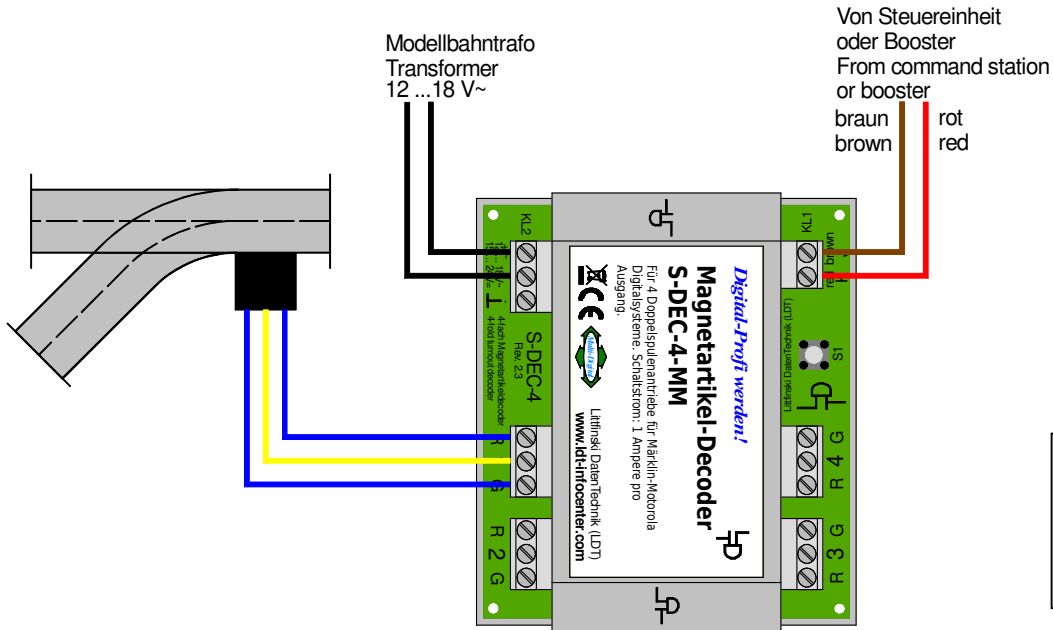

Power supply (black wires at above sample) will be required for the module itself and for the switching of the coil drives. The decoder module requires a spacing current flow of about 0.1 Ampere. Each output can cover a maximum switching current load of up to 1 Ampere.

By connecting the supply voltage of 12 – 18 Volt ~ please pay careful attention that you use the two inputs of the clamp KL2 which are marked with “~”. One of the two terminals of the supply voltage shall never be connected to the ground output “⊥” of the 3 poles clamp KL2. If this happens the decoder will be destroyed as shown within the following connection sample.

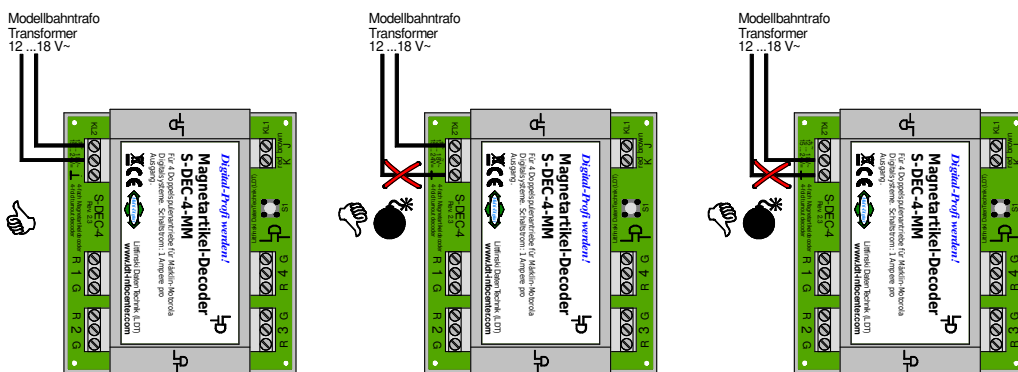

The turnouts or signals have to be connected with three cables (**blue** / **yellow** / **blue**) which can be of a preferable short length by a considerable close distance of the decoder to the respective turnout or signal. The common conductor of the turnout- or signal-drive (**yellow**) shall be connected to the middle contact of the decoder module marked by a digit. The clamps marked with “G” and “R” are supposed for the coil drives and are indicating the turnout position to be switched (G for straight and R for round).

General Note

If it is required to extend the connection cables of a turnout drive it has to be taken care of a sufficient diameter of the connection wires. For a maximum current of 1 Ampere at the decoder output is the ordinary used wiring of 0.14 mm² not sufficient. We recommend to use wires of 0.5 mm² for a sufficient installation to extended turnouts or signals.

If the available digital current (the Central Station 2 60214 requires about 3 Ampere and the 60215 about 5 Ampere) will be not sufficient for the operation of the layout it will be required to use an additional digital amplifier (= Booster e.g. "DB-2" or "DB-4"). This requires naturally additional wiring installation and further cost (expensive digital current!).

The next sample shows the connection of two of four possible turnouts and the connection of a further decoder module for an additional group of four turnouts.

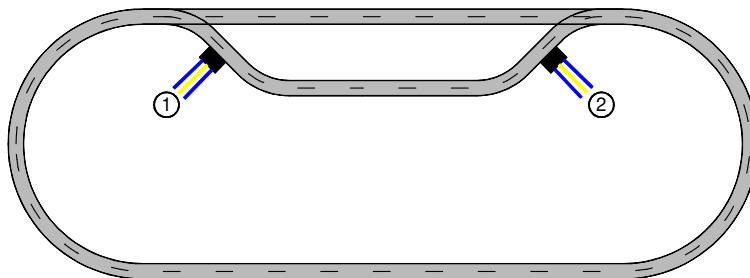

Connecting several Turnout Decoder S-DEC-4-MM (page_549)

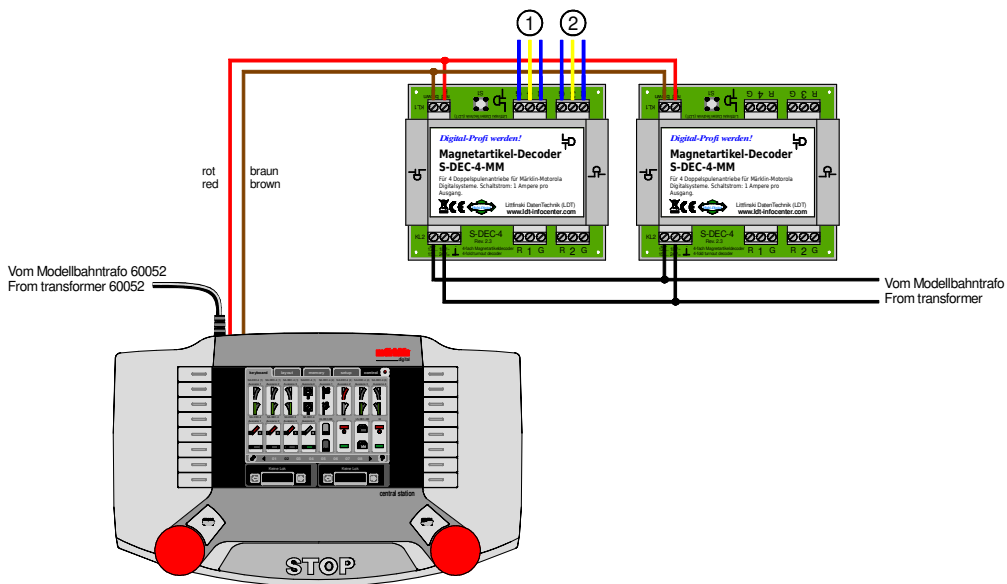

It is recommended to install a separate second main ring conductor for the digital current to the turnout- and switch decoder (**red / brown**) and a third main ring conductor for the voltage supply (**black**).

The digital information for the accessory decoders should never be taken directly from the rails. The driving locomotives can influence the digital signal by producing continually a kind of loose contact signal. This can result to the problem that the decoder cannot understand the signal. For this reason will be the loc commands continually repeated.

Especially for the switch commands which will not be transmitted several times as done by the loc commands is it possible that commands will be getting lost if the digital information has been taken directly from the rails.

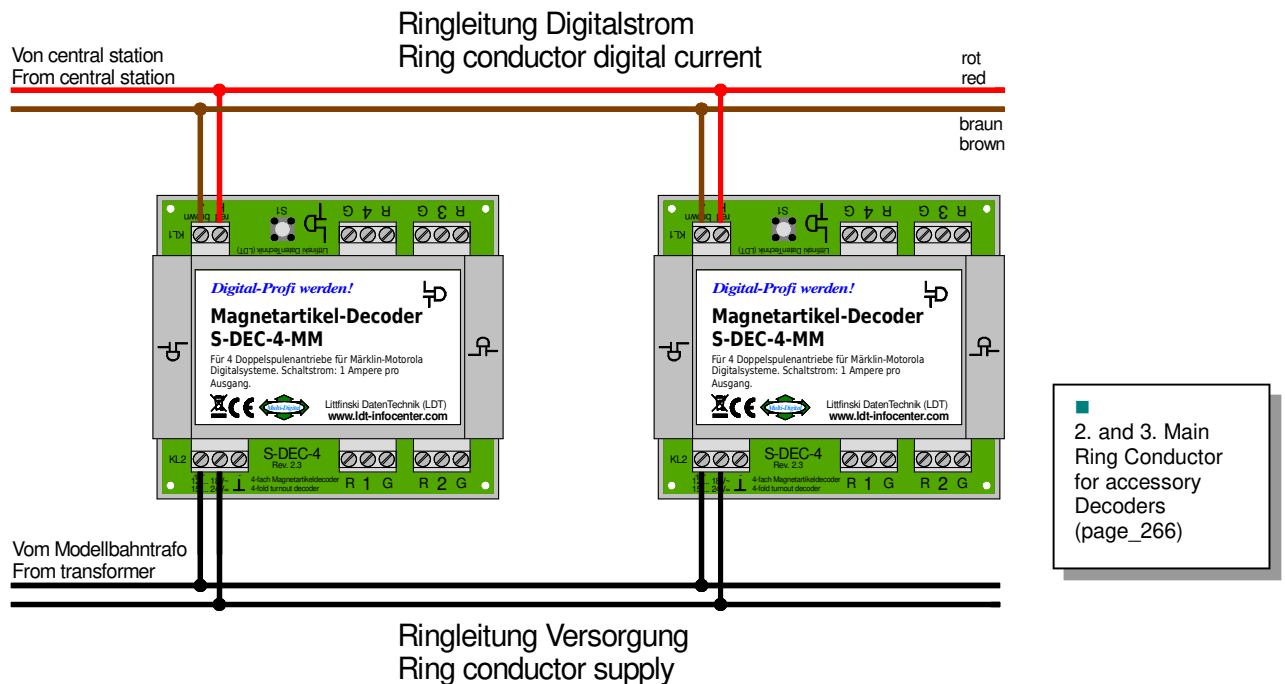

There are as well some recommendations for the wire cross-section dimension to be used for the two main ring conductor wires. As there will be a low current flow only, the wire dimension can be a little smaller.

length of the cable	recommended cross section
up to 10 m	0.75 mm ²
more as 10 m	1.0 – 1.5 mm ²

At least after completion of the wiring installation you should start the first test and the placing of suitable a digital address for the turnout (or signal).

THE FIRST PROGRAMMING

The assignment of digital addresses has to be carried out individually for each module. The address is valid for the respective complete group of four (e.g. 1 - 4, 5 - 8, 9 - 12 etc.). For setting the address (= read-in address) you have to connect a turnout to the output 1 at the module.

Before you can start programming the decoder within the MOTOROLA-Data Format via the “keyboard” of the Central Station 2 you have to tip at the section “**control**” on both loc-controller onto the picture of the loc and than select “**no loc**”. If there will be indicated on both loc-controller “**no-loc**” you have to select at the section “**setup**” the “**new start**”. After the new start of the Central Station 2 you have to change into the “**key-board**”.

The turnout will start switching at a 1.5 second interval after activating the programming key at the decoder. The decoder module is now in a learning mode. Now it is required to select and activate a turnout (1 – 4, 5 – 8, etc.) at the keyboard of the central unit.

The decoder module takes over the four addresses for the four outputs and confirms the setting by switching the connected turnout for a short period a little faster. Depressing again the programming key at the decoder will complete the setting of addresses. The addresses are now permanently stored at the decoder.

General Note

Our tip: Carry out the set-up of digital addresses before installing the decoder module below the layout because the handling of the module with all connections is much easier at a working bench. After address setting please mark the module with the assigned digital addresses (e.g. label marked with a pencil “5 – 8” for the second group of four addresses).

With this procedure the functional test has been already performed and a later malfunction after installation (e.g. defect module) can be prevented. Doing this after final installation of the unit this would be a difficult time consuming procedure.

SUPPRESSION OF INTERFERENCES

Technical Tip

End-off switched coil drives of turnouts can initiate interferences and therefore influencing the digital system e.g. with unreliable switching of turnouts. This problem can be solved by slipping 10 ferrite pearls onto the common connection wire (yellow) of the turnout drives. This has to be done very close to the coil housing.

Ferrite Pearls for the suppression of interferences by Coil Drives (page_238)

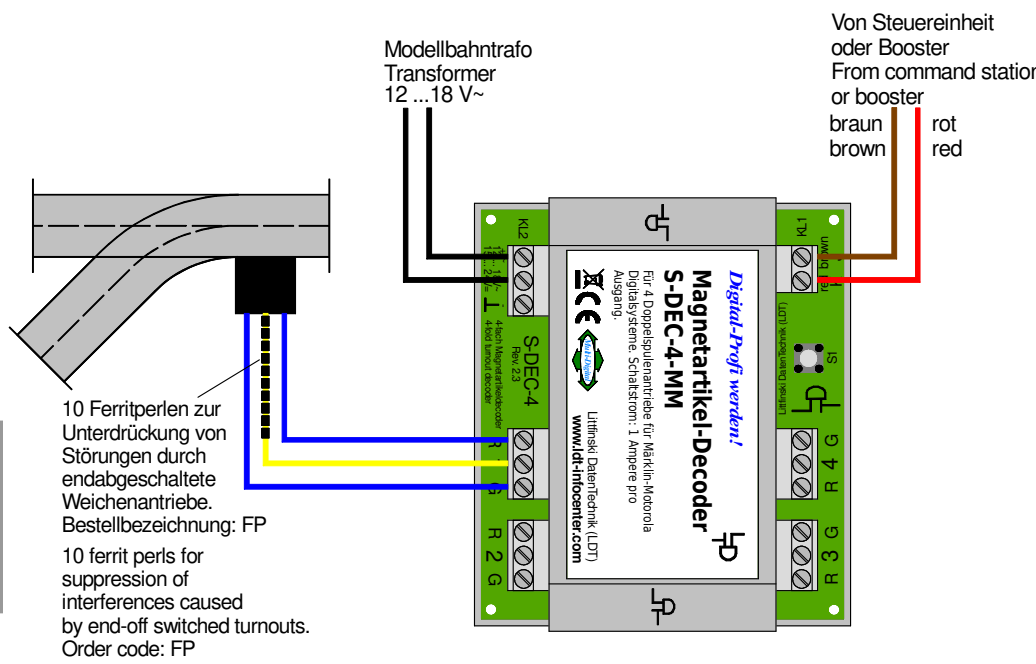

The ferrite pearls are available by LDT under the order code “FP”. The connections and the operation of the turnouts as well as the programming the decoder will not be influenced.

FURTHER INFORMATION

Additional information about the operation of digital model railway components and further helpful connection samples are available within the operation instructions received with every purchased module and device and at our extensive Internet page. All mentioned sample connections can be loaded down as PDF files (e.g. page_549.pdf) and printed at an A4 format.

Internet: www.ldt-infocenter.com

Authors: Harry Kellner and Peter Littfinski

Subject to technical changes and errors.
© 03/2022 by LDT